





# BASIX VALVE TYPE T/H



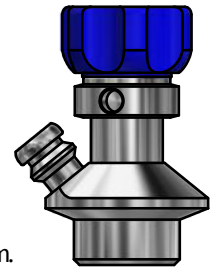

ART. NO. 450141

## GENERAL

-  The KEOFITT BASIX Sampling Valve is our CIP-able sampling valve for less demanding applications. Replaces non-hygienic sampling cocks. More than 20 different configurations available.
-  The sampling valve can be used for any process sampling for chemical and/or physical analysis.
-  Cleaning: Valve in open position: Cleanable by means of CIP using the detergent solution suitable for the actual process media. For further advice, please contact Keofitt. Not recommended for autoclave due to plastic parts.
-  Designed for sampling of liquids with a viscosity of up to approx. 100 cP containing no particles larger than Ø1.5 mm. Sampling of more viscous liquids is possible, only will it take longer (depending on process pressure).



## FEATURES

-  Installation: Tank welding
-  Operation: Turn knob - spring loaded (opens counterclockwise)
-  Head assembly: Hand tight using a tommy bar or maximum 15 Nm. Tommy bar included (#900118).
-  Outlet: Hose piece
-  Membrane: Silicone (#400051)

## CERTIFICATION\*

- EU EC 1935/2004 · EU EC 2023/2006 · DK No. 1248 10/2018 · 3-A Certificate · 3.1 Material Certificate
- ATEX 2014/34/EU · PED 2014/68/EU · FDA CFR 21 §177.2600 · USP Class VI · Keofitt DoC

## TECHNICAL DATA

### Material (process contact)

- Steel parts                   AISI 316L (1.4404)
- Membrane                   SILICONE, GREY (#400051)

### Material (without process contact)

- Steel parts                   AISI 304 (1.4307)
- Knob                         PA6 (Blue)

### Membrane

- Article                       SILICONE, GREY (#400051)
- Certification\*             · EU EC 1935/2004 · EU EC 2023/2006
- DK No. 1248 10/2018 · FDA CFR 21 §177.2600 · USP Class VI
- REACH · RoHS · ADI Free · Keofitt DoC

### Surface Treatment

- Outside                     Ra ≤ 1.2 µm
- Inside (wetted surface)   Ra ≤ 0.8 µm
- Process connection       Ra ≤ 0.8 µm

### Pressure & Temperature

- Pressure                    0 - 6 bar / 0 - 87 psi
- Temperature               1 - 130°C / 34 - 266°F
- Air supply                  -

### Net Weight

- kg/lbs                       0.298 kg/0.656 lbs

### Spareparts

- 774501                       PARTS FOR BASIX VALVE BODY
- 774441                       PARTS FOR 4KAI/BASIX HEAD H

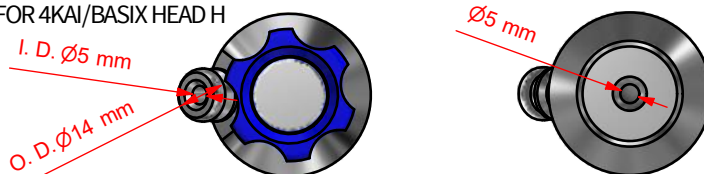
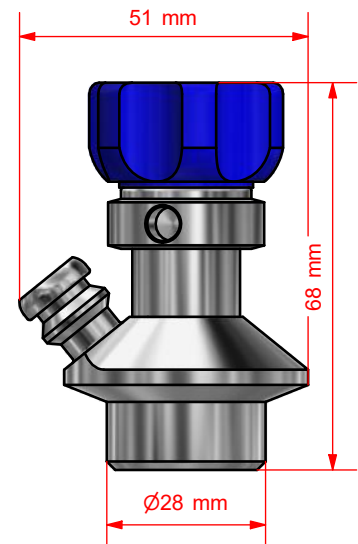

\*For further information and download please visit [www.keofitt.dk](http://www.keofitt.dk)